



15+years Manufacturing
Quality is our culture!



0086-29-88763980

info@toptionlab.com

GaoXin District, XI'AN CHINA

www.topdistillation.com

TOPTION INSTRUMENT CO.,LTD



Molecular Distillation One Stop Solution

Quality Manufacturing 15 Years

TOPTION INSTRUMENT Co., Ltd. has spent 15+ years becoming a world leading manufacturer engaged in the research, development, production, sale and service of molecular distillation equipment, wiped film evaporator, crystallization reactor, dewaxing / winterization filter, nutsche filter, rotary evaporator.

Since 2004 TOPTION'S equipment has been used and praised in many counties including United States, Canada, Poland, Spain, Italy, Sweden, Switzerland, Colombia. We are your dependable partner in cbd oil distillation industry, we are flexible, intelligent, and truly care about your benefits potential of a well-orchestrated vacuum distillation system. We want your cbd business brand to be remembered and welcomed by your customers, not the practicalities of cannabis market.

TOPTION has passed ISO9001 & CE certification, UL certification is in process, we work closely with our clients to deliver a successful and extraordinary cbd distillation system, choose TOPTION to maximize your benefits. TOPTION will be your TOP OPTION.



CONTENTS

Separation CBD oil	03
Extraction CBD oil	13
Dewaxing / Winterization	15
Crystallization / Filtration	16
Concentration recycling ethanol	23
One stop solution	29

Export Bus.

Quality Assura

R & D Capacity

Production Fle

Company

Export Bus.

Quality Assura

R & D Capacit

Production Fle

Company

Molecular distillation equipment

Short path (molecular) distillation system is considered as the safest mode of separation and to purify the thermally unstable molecules & related compounds with low volatility & elevated boiling point. In the high vacuum environment, molecular distillation has the advantages of low distillation temperature, short heating time and rapid separation.

A complete molecular distillation plant should include

Short path evaporator	Heating system (RT-200°C or RT-300°C)
Material feeding pump	Cooling system (-20°C~180°C or -40°C~RT or -80°C~RT)
Material discharging pump	Vacuum system (0.05pa / 1pa / 10pa)

Product parameters (Lab-Pilot-Industry wide capacity range)

Model	Evaporator Area (㎡)	Internal Condenser Area (㎡)	Capacity (L/h)	Mixing Motor Power (W)	External condenser + Cold trap
MDS-10	0.10 (5 Inch)	0.15	3-15	370W	1+1
MDS-20	0.20 (7 Inch)	0.40	5-25	370W	1+1
MDS-30	0.30 (8 Inch)	0.50	5-30	550W	1+1
MDS-50	0.50 (12 Inch)	2.00	10-50	1500W	1+1
MDS-100	1.00 (14 Inch)	3.00	30-200	3000W	1+1
MDS-200	2.00 (20 Inch)	5.00	30-260	3000W	1+1
MDS-500	5.00 (32 Inch)	10.00	50-300	4000W	1+1

(MDS-10~50 For Research, MDS-100 / 200 / 500 for production.)

Quality is our culture

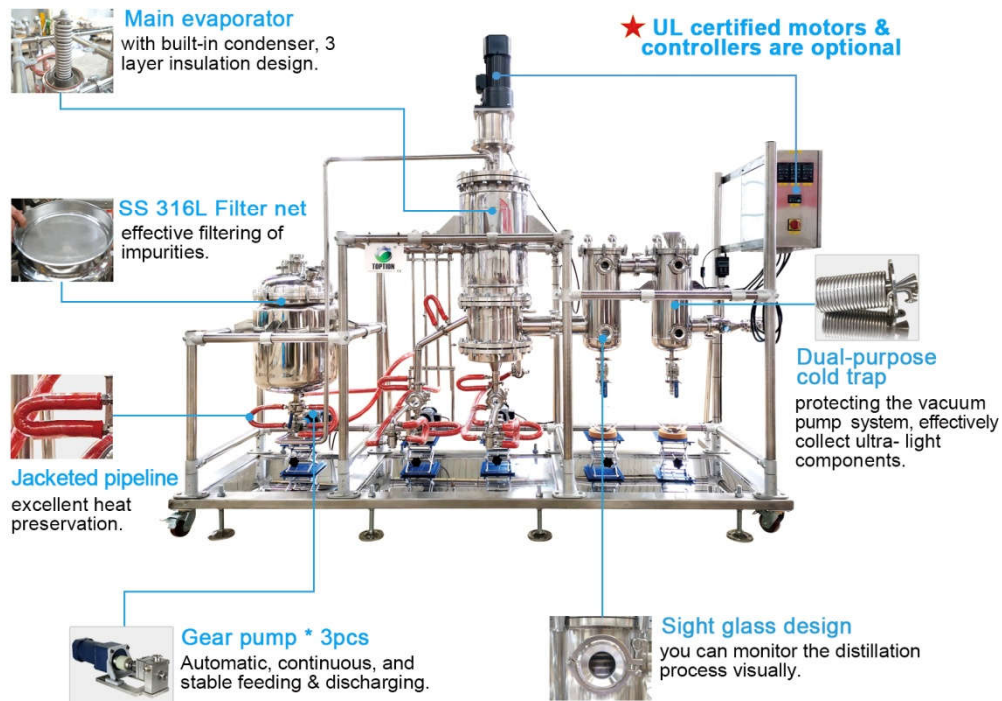

"C"(E) Series

- UL certified motor & controller are optional.
- Jacketed Stainless Steel Material Feeding Tank.
- Gear Pump Material Feeding Type.
- Gear Pump Collection Type.



MDS-10CE

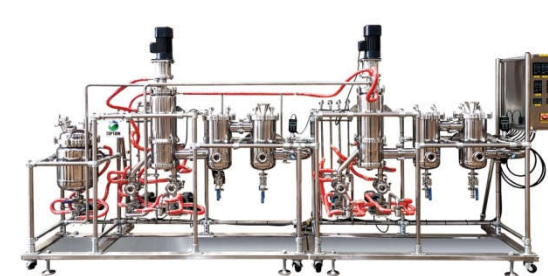

MDS-30CE Two stages type

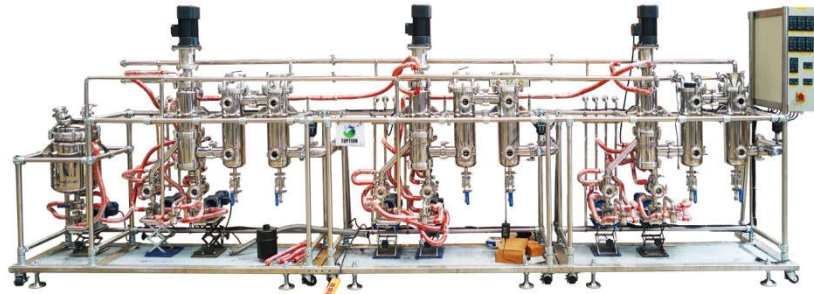

MDS-10CE Three stages type



MDS-30CE



MDS-50CE



MDS-100CE



MDS-200CE Industry types customize

Heating System & Cooling System



Vacuum System-ultimate vacuum 10Pa,1Pa,0.05Pa (UL certified pumps are optional)

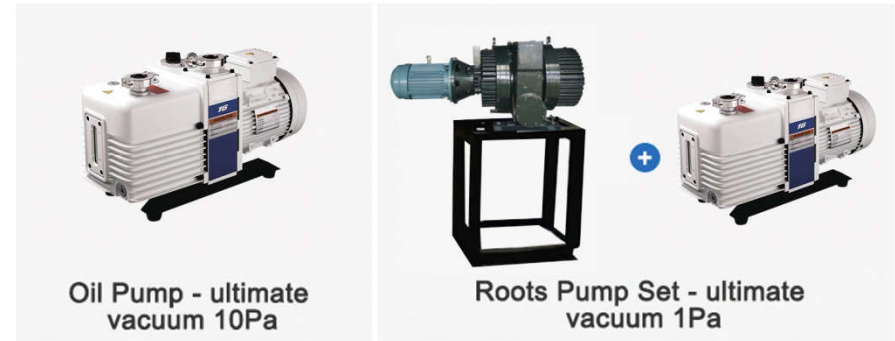

Oil Pump - ultimate vacuum 10Pa

Roots Pump Set - ultimate vacuum 1Pa

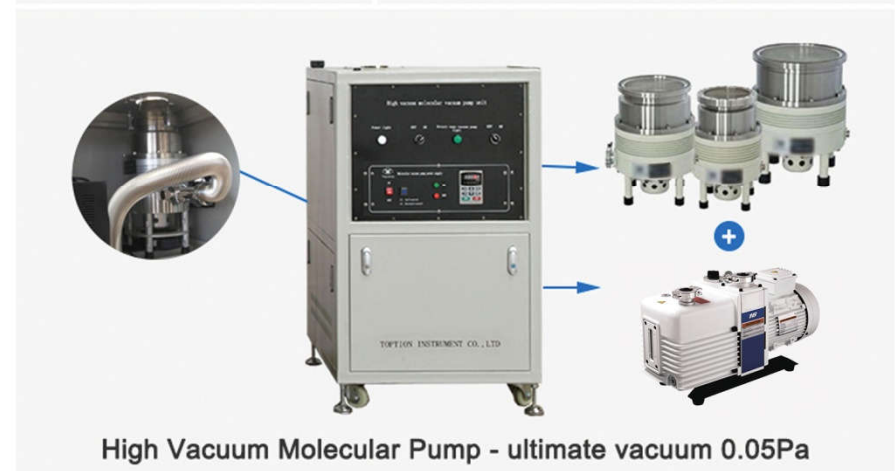

High Vacuum Molecular Pump - ultimate vacuum 0.05Pa

Product Analysis



- 1 316L stainless steel material: durable & corrosive-resistant, excellent thermal conductivity for high processing rates.
- 2 Filter net: effective filtering of impurities.
- 3 Jacketed pipeline: excellent heat preservation.
- 4 Full jacketed pipe (feeding and collection section)
- 5 Electric machinery: Magnetic sealing strong motor to drive rotation
- 6 Main evaporator: with built-in condenser, 3 layer insulation design
- 7 Material charging pump: Automatic, continuous, and stable feeding & discharging.

Delicate details

<p>316L stainless steel Made by food grade 316L stainless steel, durable and corrosive-resistant, with excellent thermal conductivity for high processing rates.</p>	<p>Filter net effective filtering of impurities.</p>
<p>Wide options Wide choices of sizes applicable to lab, pilot and industry production.</p>	<p>Fully jacketed Fully jacketed design can make full insulation of whole system with circulating hot oil for precise control of insulation temperature.</p>
<p>Fully automatic Fully automatic operation by feeding and collection pumps, make continuous and high efficient working process.</p>	<p>Shortest lead time Shortest lead time and inventory available, strong technical support including on-line and on-site.</p>

Turnkey solution provided

Turnkey solution provided, including main distiller, supporting thermostatic equipment and vacuum pumps for one stop service.



Application of molecular distillation equipment

Molecular distillation is applied for creating a high value clear distillate from Plant Oil Concentrates, such as refine cannabis and hemp concentrates into a golden clear distillate that can be infused into a variety of edible products or fine oils to be used in vape cartridges or other products.



Choose TOPTION to maximize your results. We believe, TOPTION will be your TOP OPTION.

15 Years quality manufacturing -reliable quality guarantee	+	24 Years experience chemical engineers team-professional customize	+	Large market share in CBD industry - Maximize your returns	+	Fast response technical support team & sales team
Our engineers to your facility for installation/training is available	+	Factory visit before delivery, installation & commissioning training	+	Strong production capacity to promise the qualified products & on-time delivery	+	Experienced sales with technical team standing by for aftersales support

Focus on detail reliable quality



More than 15 years manufacturing experience



1. Cryogenic centrifugal extraction

Cryogenic centrifugal extraction - Remove reagent - Decarburization tank - Molecular distillation.

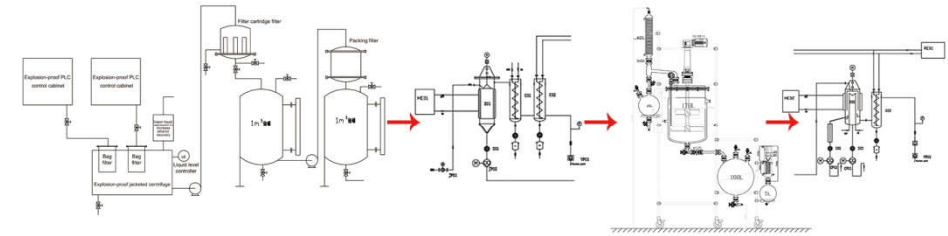

2. Supercritical Extraction

Supercritical extraction – dewaxing filtration system – concentration (scraped film equipment / rotary evaporator) – molecular distillation system.

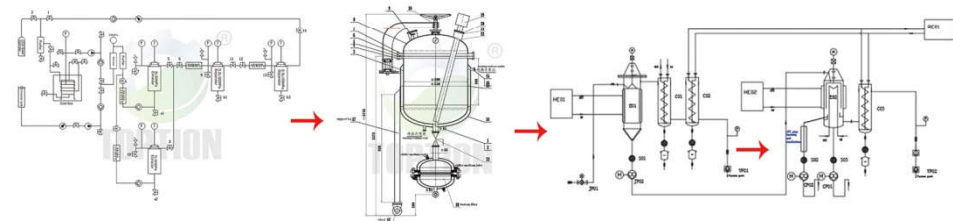

3. Solvent Extraction Method – Ultrasonic Extraction

Ultrasonic extraction – Multi union bag-type filter - Alcohol recovery – Scraper concentration / rotary evaporator concentration – molecular distillation .

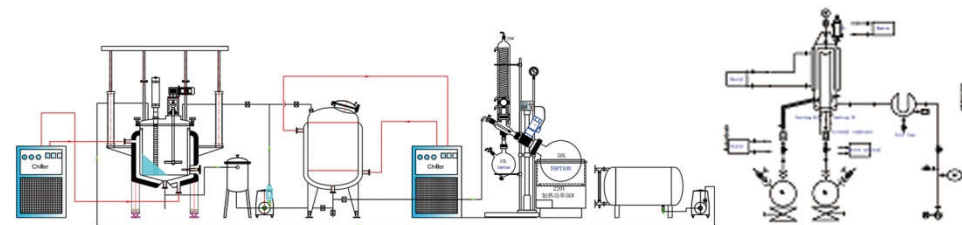

Centrifuge cbd extraction



-  High extraction rate
-  High alcohol removal rate
-  Low temperature rating

- ✓ JB/T10769.1-JB/T10769.2-2007 Manufacturing Standards
- ✓ GB19815-2005 Safety Standard
- ✓ Explosion Proof
- ✓ Easy material loading / unloading
- ✓ Single person operation
- ✓ Variable speed control
- ✓ Technical support
- ✓ Closed-loop Technology
- ✓ Balance Accuracy
- ✓ Fully Automatic
- ✓ Large mirror structure
- ✓ Vacuum jacketed insulation
- ✓ 12 month parts / labor warranty

TOP Series cbd extraction centrifuge advantages

1. Low temperature -60 °C to 50 °C acceptable.
2. 304 & 316L sanitary stainless steel.
3. Large mirror structure for a clear view of the inside of centrifuge.



4. Optional configuration: oxygen content detection and protection system, cart structure.

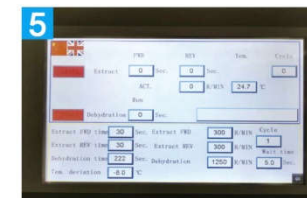

5. Fully automatic extraction process, the program can set drum positive reversal rotation speed, time & cycle times, and can switch manual control. The dehydration rotation speed and time can be set.
6. Three-phase 220V explosion-proof motor, PLC & touch screen control, frequency conversion control cabinet. Equipped with two inlet / intake tubes, one with valve vacuum port, one drain port, and coolant inlet and outlet. The centrifuge body has a cooling jacketed layer.
7. Display temperature & pressure.
8. Zipper filter bag for quick loading and unloading. Designed for single person operation

Technical parameter

Model	Loading amount per batch		Alcohol volume (L)	Coolant volume (L)	Cooling area (m²)	Feed port with valve and sight glass	Washing port with valve	Vacuum port with valve	Outlet port with valve and sight glass	Jacket inlet & outlet with valve
	(KG)	(lbs)								
TOP15	3	7	30	6	0.33	✓	✓	✓	✓	✓
TOP25	5	11	40	8	0.44	✓	✓	✓	✓	✓
TOP45	10	22	85	16.5	0.6	✓	✓	✓	✓	✓
TOP65	12	26	105	21	0.77	✓	✓	✓	✓	✓
TOP115	23	51	175	28	1	✓	✓	✓	✓	✓
TOP145	28	62	210	34	1.2	✓	✓	✓	✓	✓
TOP250	50	110	380	45	1.6	✓	✓	✓	✓	✓

50L/100L/200L wax removal filtration equipment

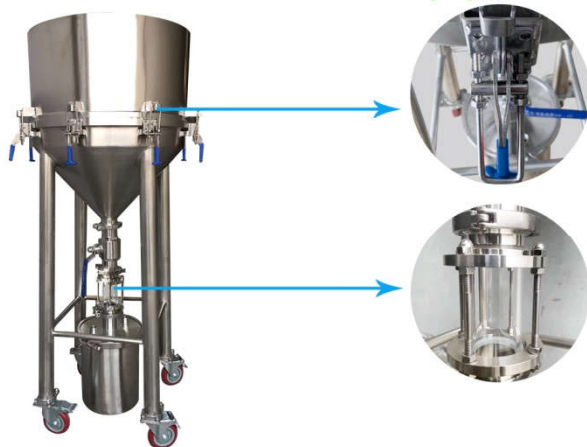

TOPTION filtration equipment enables high throughput wax removal from winterized ethanol solutions, which is professional designed for our particular customers who are work in plant oil extraction industry.

Product analysis

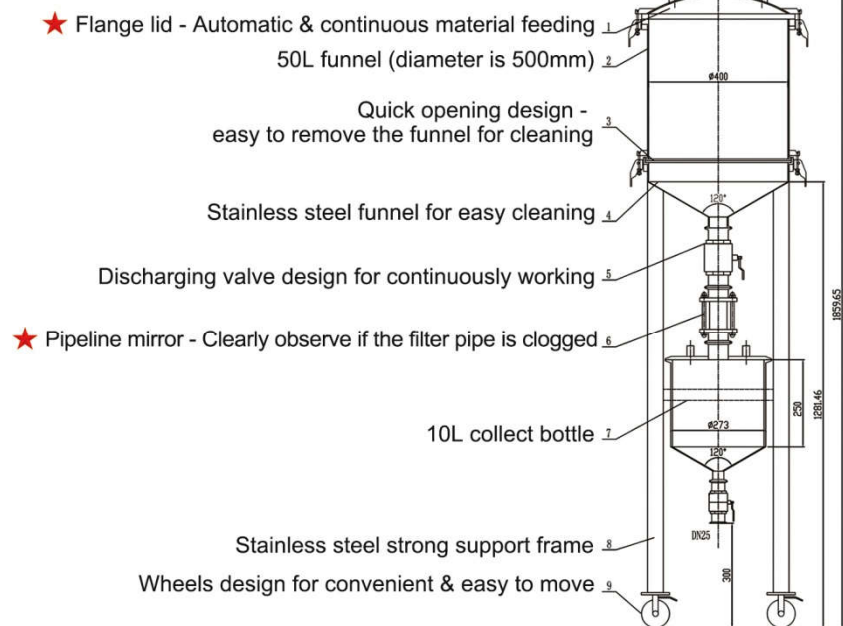

Crystallization/Filtration to remove impurity



Recrystallization Vacuum Filtration

Dewaxing filter

Recrystallization is not generally thought of as a separation technique, rather, it is a purification technique in which a small amount of an impurity is removed from a compound. However, if the solubility properties of two compounds are sufficiently different, recrystallization can be used to separate them, even if they are present in nearly equal amounts. Recrystallization works best when most impurities have already been removed by another method, such as extraction or column chromatography.

Working process

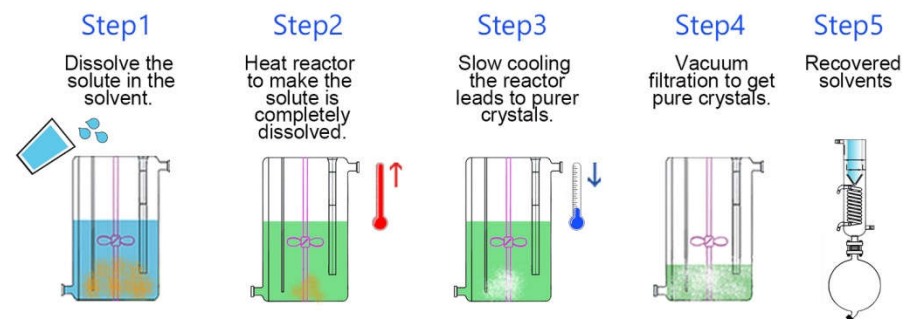

50L crystallization reactor with filtration system

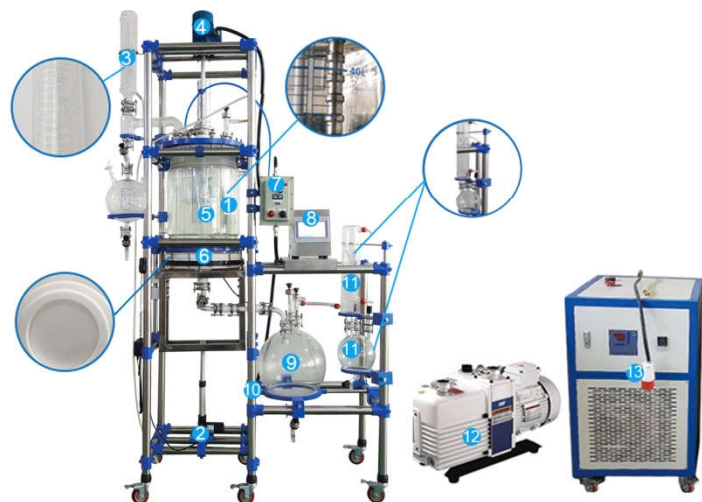

1 Ultrasonic emulsification customize	2 Electric automatic lifting
3 Efficient condenser	4 Strong stirring motor
5 PTFE stirring agitator	6 Sand core filter plate
7 Filtration reactor controller	8 Ultrasonic controller
9 Collection flask	10 Strong stainless steel frame
11 Condenser + collection flask, recycle organic reagents, and protect vacuum pumps	
12 Vacuum pump	13 Heating & cooling circulator bath

Main features

1. Reactor cover port customize - convenient & easy to do liquid/solid feeding, stirring, temperature & phmeasure, etc.

2. Sand core filter plate with PTFE fixing gland - fast flow, good chemical corrosion resistance & sealing performance.

★ 3. Ultrasonic emulsification with PTFE agitator - sample mixing is more complete, better separation of materials.

★ 4. Electric automatic lifting



(1) Filter plate can be disassembled & washed easily.

(2) Reaction vessel & filter plate as a whole part automatic lifting - Suitable for large amount of effective crystal, which are not polluted and easy to take out.

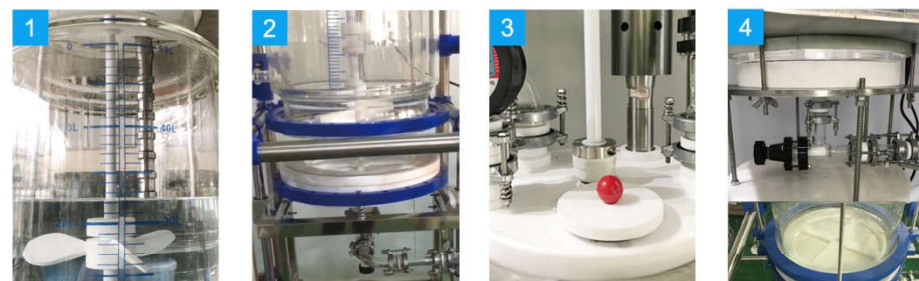

5. Cold trap & collection flask - recycle organic reagents, protect vacuum pumps.

6. Heating and cooling circulator bath (-80°C~ 250°C) - accurate temperature control according to customer's process requirements.

7. Vacuum pump is optional to make your research more efficient.

Nutsche filter dryer

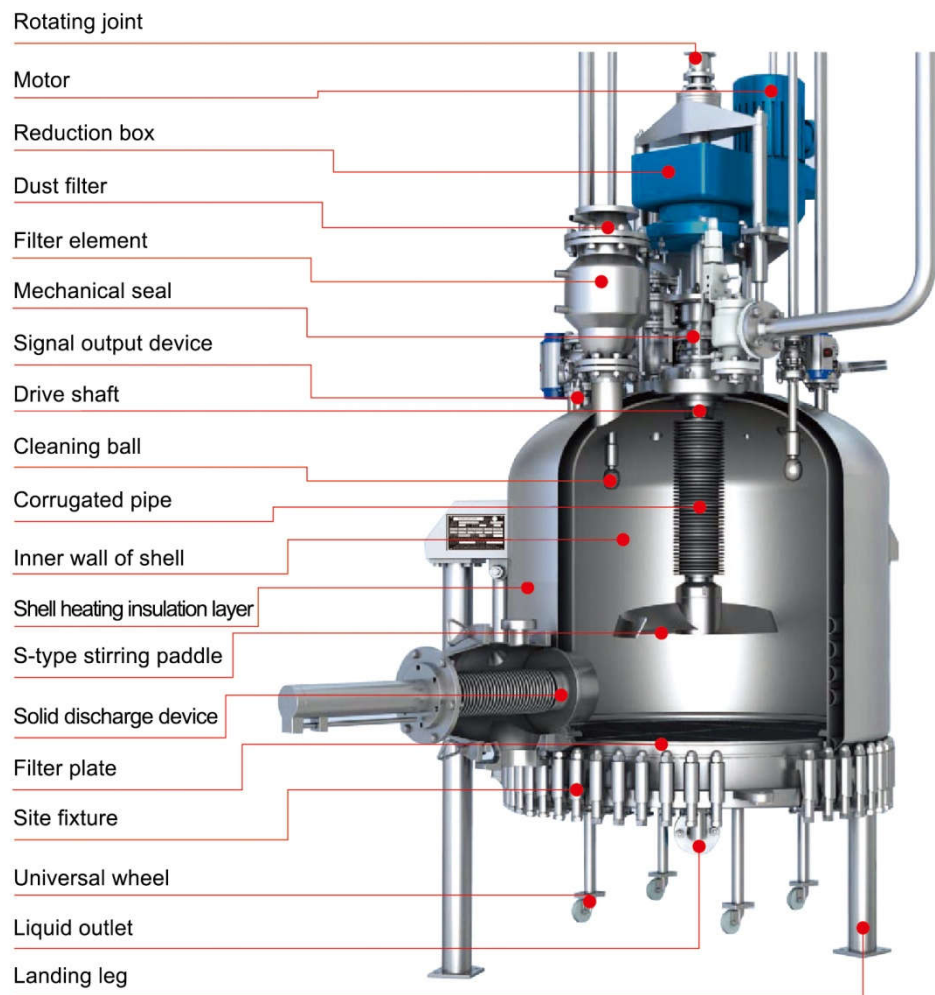

With its high cost performance, TOPTION nutsche filter dryer has successfully become an effective alternative to the filter and dryer, and has an efficient filtration and drying process. Makes the non-metallic lining products be applied to separate highly corrosive solid and liquid media.

Technical parameter

Standard type	DN500	DN600	DN800	DN1200	DN1400	DN1600	DN2000	DN2300	DN2800	DN3000	DN3200
Nominal filtration area (㎡)	0.19	0.28	0.5	1.0	1.5	2.0	3.0	4.0	6.0	7.0	8.0
Internal diameter (mm)	500	600	800	1200	1400	1600	2000	2300	2800	3000	3200
Nominal volume (m3)	0.14	0.26	0.53	1.36	1.19	2.99	5.06	6.76	10.8	14.8	16.8
Barrel height (mm)	600	750	900	950	1100	1200	1200	1250	1250	1550	1550
Filter cake height (mm)	120	120	200	250	300	350	400	450	450	600	600
Blades rise height (mm)	150	150	300	300	350	400	450	500	500	550	550
Stirring motor power (KW)	2.2	3.0	5.5	7.5	11	15	18.5	18.5	22	37	45
Net weight (Kg)	1350	1560	2230	4300	5890	6630	11350	13850	16300	18650	21230
Equipment total height (mm)	2560	2890	3130	3900	4360	4680	5150	5280	5520	5750	5850

Filtration, washing & drying steps

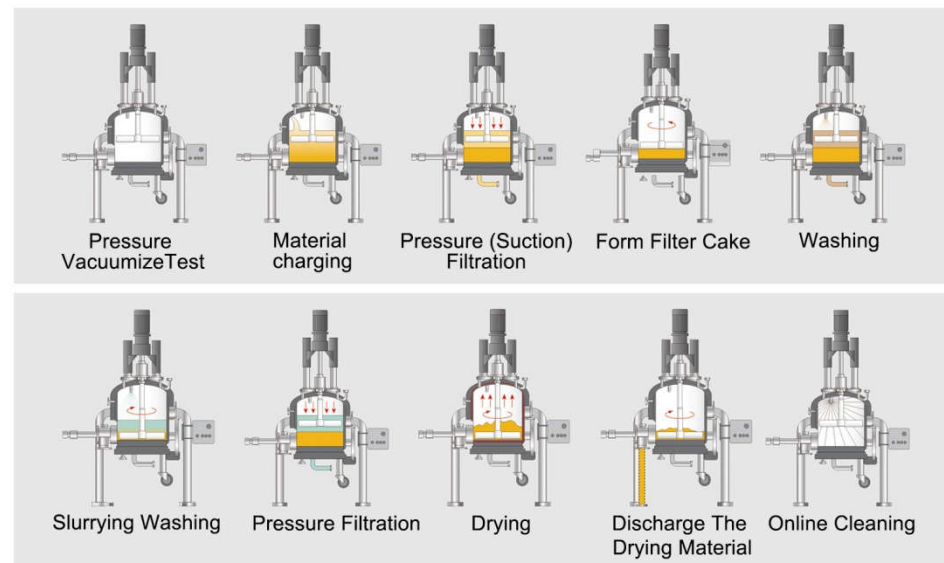



1L-2L

- Pneumatic decelerating agitator motor, speed is adjustable.
- The stirring blades can lift manually .
- Solid discharge requires to take the chassis out together with the filter cake.
- Low noise.



5L

- Explosion-proof variable frequency electric stirring.
- Stirring blade manual lifting.
- Solid discharge requires to take the chassis out together with material.
- Variable frequency motor, through the knob precise adjust the speed.



20L

- Electric stirring.
- Hydraulic electric lifting of stirring blade.
- Hydraulic electric lifting of filter chassis.
- Material discharging valve is hydraulic automatic discharging.
- Variable frequency motor, through the knob precise adjust the speed.



50L

- Electric stirring.
- Stirring blade manual lifting.
- Remove the filter chassis manually.
- Material discharge valve is manual discharge, manually open the discharge valve and scrape out the material by the blade.
- Variable frequency motor, can adjust the frequency and speed through the speed control knob.



200L

- Electric stirring.
- Hydraulic electric lifting of stirring blade.
- Hydraulic electric lifting of filter chassis.
- Material discharging valve is hydraulic automatic discharging.
- Variable frequency motor, through the knob precise adjust the speed.

Concentration recycling ethanol

- Wiped Film Evaporator – Solvent Removing High Efficient Type



1m²
(Wiped film evaporator)



2m²
(Wiped film evaporator)

Technical parameter

Model	Evaporator Area(m ²)	Height (mm)	Capacity (L/H)
PWFS -0.1	0.1	2300	2-10
PWFS -0.2	0.2	2500	10-20
PWFS -0.3	0.3	2700	15-30
PWFS -0.5	0.5	3300	20-50
PWFS -1.0	1.0	4300	50-100
PWFS -2.0	2.0	4600	100-200
PWFS -3.0	3.0	5400	100-300
PWFS -5.0	5.0	6400	150-405
PWFS -6.0	6.0	7200	180-550

- Rotary Evaporator - Solvent Removing Economical Type



(1L 2L 5L 10L 20L 50L 100L Easily scalable)

Rotary evaporator is mainly used in pharmaceutical, chemistry and bio-pharmaceuticals industries, for concentration, crystallization, drying, separation and solvent recovery.

Technical parameter

Model	Rotating bottle capacity (L)	Collecting bottle capacity (L)	Temperange (°C)	Lifting method	Heating power
RE-52AA	0.5L	0.5L	RT-99±0.2	Electric lift	1.1KW
RE-2000A	2L	1L	RT-99±0.2	Electric lift	1.5KW
RE-5000A	5L	3L	RT-99±0.2	Electric lift	2.2KW
RE-5210A	10L	5L	RT-99 (170) ±0.2	Electric lift	3KW
RE-5220A	20L	10L+3L	RT-99 (170) ±0.2	Electric lift	5KW
RE-5230A	30L	10L+10L	RT-99 (170) ±0.2	Electric lift	5KW
RE-5250A	50L	20L+10L	RT-99(170) ±0.2	Electric lift	7KW
RE-52100A	100L	50L+10L	RT-99 (170) ±0.2	Electric lift	16KW

Advantage description of 50L

01 Dual condenser design
For high efficient condensation during evaporation / concentration process.



02 Dual collection flask
Easy to achieve continuous collection.



03 Large LCD display temp & rotating speed.
Automatic lifting, heating switch conveniently.



04 Check valve
Built-in automatic check valve, for better vacuum degree and good continuously operation.



05 Combination Valve
Gas guide flask unique PTFE combination valve, can control air flow & liquid flow. Material charging & discharging can be finished during rotavapor working, don't need to stop it.



06 Anti-corrosion & Wearable sealing system
Specially designed and precisely manufactured. Enable system ultimate vacuum rate reaching 1000Pa (equipped with different type vacuum pump). 90% users don't need to replace rotary seal in one year.



07 Ex-plosion proof function customize



★ 1. Explosion-proof & rotovapor integrated type



★ 2. External explosion-proof box

100L Rotary Evaporator:



- 1. Condenser
- 2. Recovery Bottle
- 3. Material discharging valve
- 4. Rotating Bottle Clamp Nut
- 5. Mechanical seal for excellent sealing
- 6. Glass Rotating Bottle
- 7. Explosion proof control panel
- 8. Water Bath
- 9. Cardan wheel

Product Display



Technical support & flexible

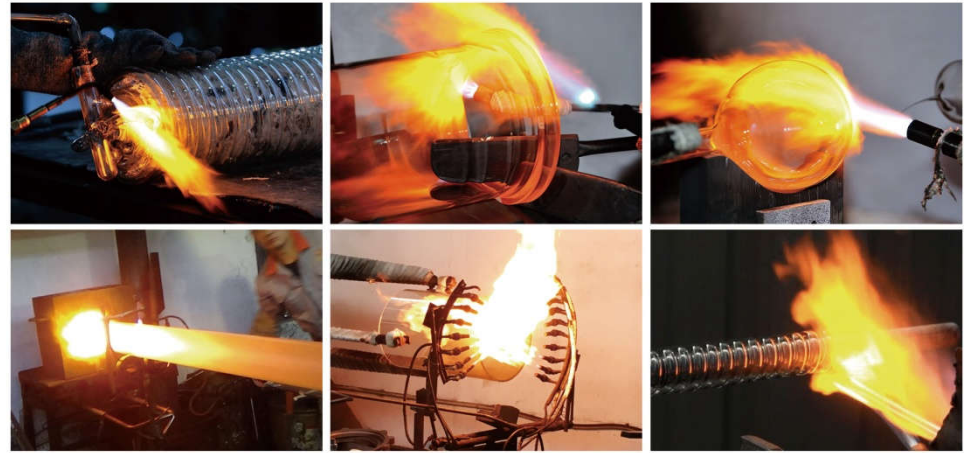

CBD oil distillation one stop solution

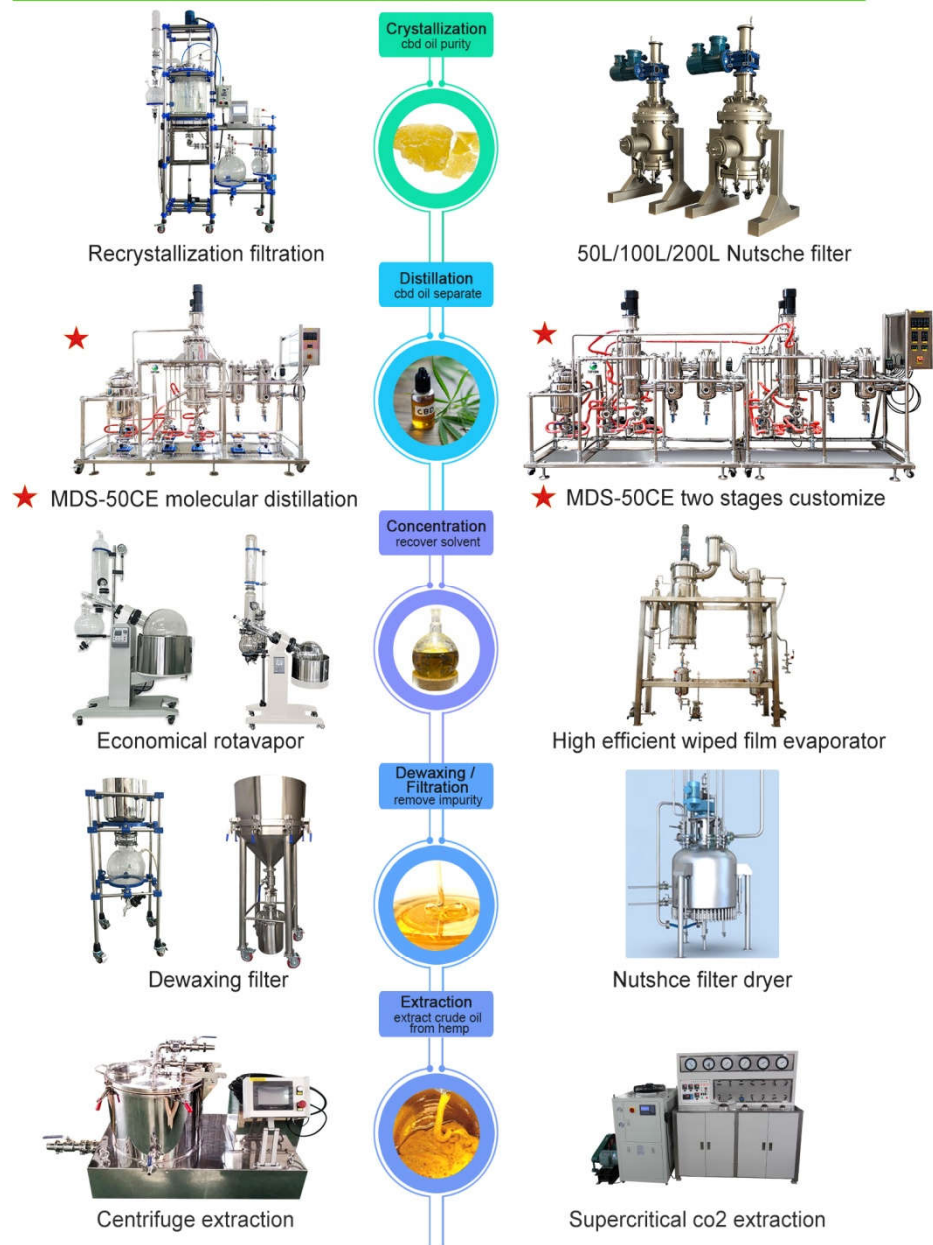

To be your dependable partner in cbd distillation industry, TOPTION are flexible, intelligent, and truly care about your benefits potential of a well-orchestrated cbd processing system. **TOPTION , TOP OPTION!**

Professional Customize

Global OEM

Technical Support

Overseas Installization / Training

Welcome visit factory to negotiate

